

## GAS CLAYPOT RANGE

- High quality stainless steel #304, hairline finish body construction with solid top 1.5mm thickness.
- Equipped with 6" or 7" oriental burner simple style easy operation concentrated firepower.
- Low combustion noise, environmental and saving energy, safe with long service life.
- Heating up quickly, the best product to keep the food fresh.
- Equipped with a high-efficiency thermocouple device for flame failure protection, ensures a safe working environment.
- Magneto pilot ignition.
- Cast iron grid, oil tray on the bottom.

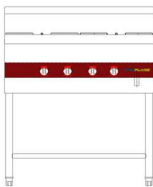
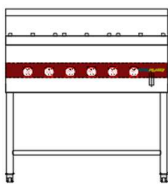
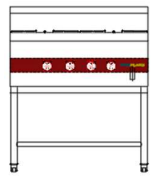
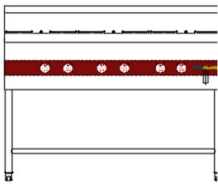

CONSTRUCTION & FEATURES

<b>SERIES 750MM</b>			
	Model	TFA-CP800	TFA- CP900
	Dimension (mm)	800 x 750 x 960H	900 x 770 x 960H
	Heat Load (kW)	5kWx4	5kWx6
Burner size (mm)	Ø150	Ø180	
<b>SERIES 900MM</b>			
	Model	TFA-CP800	TFA- CP1200
	Dimension (mm)	800 x 900 x 960H	1200 x 900 x 960H
	Heat Load (kW)	5kWx4	5kWx6
Burner size (mm)	Ø150	Ø180	

SPECIFICATIONS

# TruFlame Asian Ranges

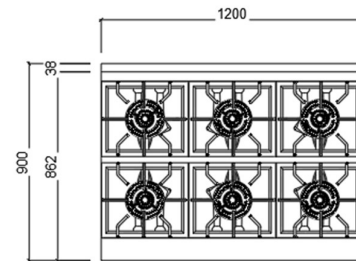
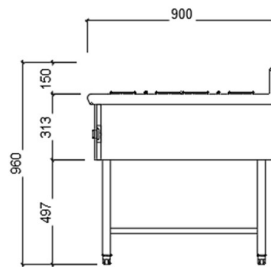
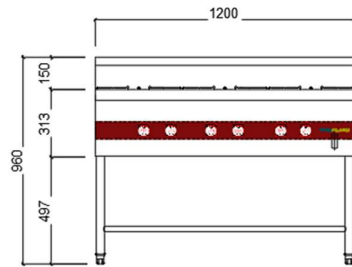
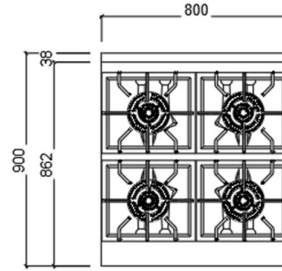
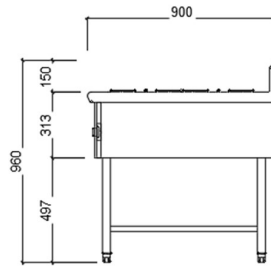
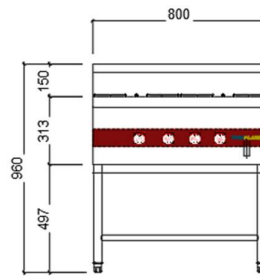
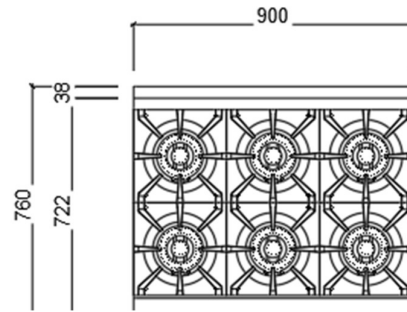
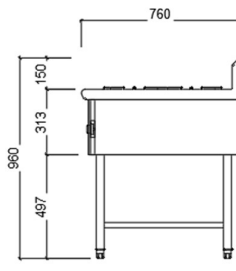
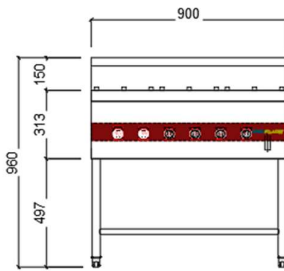
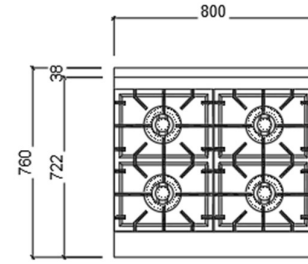
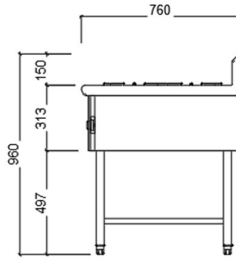
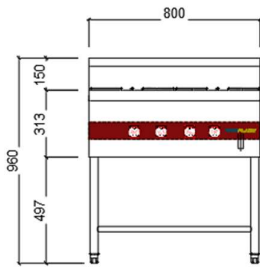

TECHNICAL DRAWINGS



m: +65- 8453-1366  
 e: [sales@trutek.sg](mailto:sales@trutek.sg)  
 w: [www.trutek.sg](http://www.trutek.sg)

TRUTEK PTE. LTD  
 470 North Bridge Road, #5-12 Bugis Cube,  
 Singapore (188735)